

Data Sheet



Article number: 02150000102

Description: Sealing Clamp S 102 W1

Measures

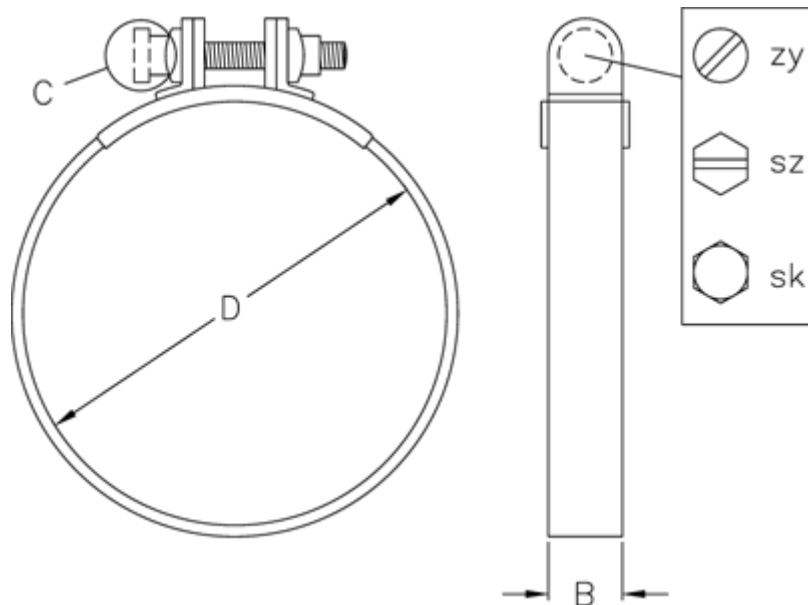

C (screw type)	= SZ
Diameter D	= 102
Width B	= 20